

K&B Duct



*Featuring the
FOREVER CLAMP
with the exclusive
"FOREVER" Guarantee.*

*Clamp Together
Ducting Catalog*



The "FOREVER" Clamp

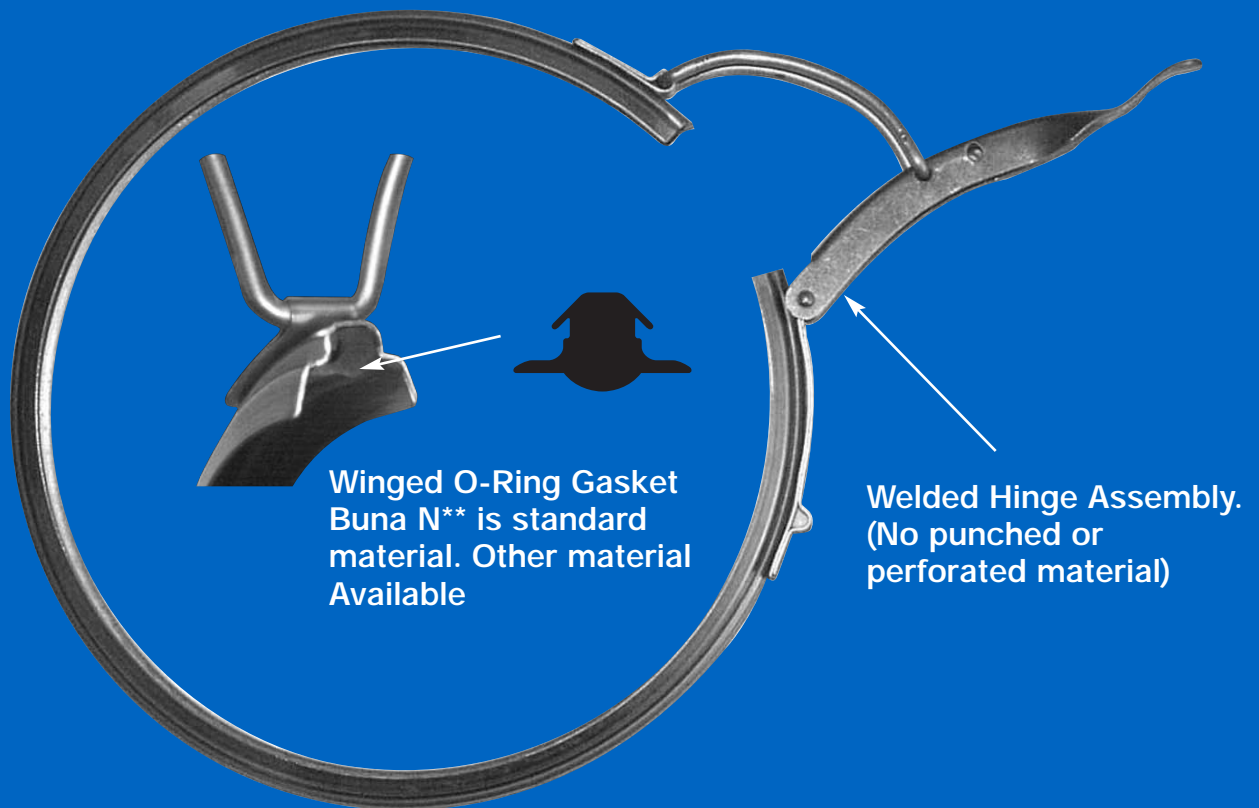

The all welded stainless steel clamp is fitted with a heavy duty, continuously reusable O-ring sealing gasket. The locking mechanism is so sturdy that it is backed with a "forever" guarantee. There are no punched or perforated parts to fatigue or bend. In fact, if it ever breaks, tears or becomes unusable, return it for free replacement. Period.

Bid Specs

K&B Clamp together Duct

Product Description: The system is a full line of duct and components. All parts are of standard sheet metal construction with a rolled lip applied to each end of the component. An all stainless over-center locking clamp is used to encompass the rolled lips, pull them together and then securely join them. Adapters enable connection to virtually any machine or existing duct.

Clamp: The lifetime guaranteed clamp is fitted with a "winged O-ring" gasket made of N-butyl rubber. The gasket is designed to fully encompass the entirety of the rolled lips including the area formed by the "v" between the rolled lips. Other gasket material is available.*

Duct and Adjustability: The duct is a nominal 5' length. Adjustable sleeves and adjustable components enable the installer to quickly make odd lengths and to adjust for a proper fit. To utilize this feature, a cut piece of pipe is slid into the sleeve or fitting and secured with an O-ring and standard clamp.

STANDARD PRODUCT

Materials: Material Duct and Components are available in galvanized, stainless (304-316) as a standard.

Gauges: Duct Standard Gauges for the duct are 26 ga for 3", 24 ga for 4-6", 22 ga for 7-12" and 20 ga for sizes 13-22". Elbows are typically one gauge heavier than standard duct gauge. All components (branches, reducers etc) are of 18 ga material.

PRODUCT OPTIONS

Material: Carbon steel and galvanized are available as an option.

Gasket Materials: Viton, Gore-tex, Red Silicone Rubber, Asbestos gaskets and O-ring material are also available.

Gauges: All duct can be provided in standard configuration in one ga heavier [REDACTED] Rolled lips can be applied to Gauges up to 10 ga by applying a rolled lip collar to fully welded duct and components. Heavy tubed elbows are available.

PRESSURE RATING

The rolled lip on the duct and fittings act as a stiffening ring and therefore allow the product to withstand much higher pressures than normally associated with spiral or other rolled duct. The duct is typically installed with the confidence in pressure applications up to 40" negative water column pressure. Higher pressures guarantees are available. To obtain this simply call K&B.



K&B Duct

K&B Clamp Together Ducting Catalog Including Flanged Ducting

Presenting a complete line of Clamp Together Ducting available from a Full Service Supplier. In fact, Kirk & Blum is the U.S. leader in industrial sheet metal. Kirk & Blum's K&B Duct is offered in the industry's most comprehensive lines—all components—in sizes from 3" through 22" including special fabrications **and including our unique "Forever Clamp"**. Larger sizes are also available in flanged ducting.

K&B Clamp Together Ducting is supplied through a nationwide network of dealer representatives, supplied from seven convenient regional K&B production facilities, with free design assistance and the easiest ordering in the industry.

Complete Systems Made Easy

Kirk & Blum is the largest manufacturer of industrial sheet metal components in the U.S. We can provide you with ALL standard and ALL special components.

K&B Clamp Together Duct can provide you with the right duct for the right application and at the right price. Mix and match angle rings and clamps to make your system quick, easy and adaptable.

K&B offers ALL components in ALL sizes from 3"-22" including 11", 13", 15", 17", 19".

Design / Take-Off Made Easy

Fill in our convenient and easy to use "tally sheet" enclosed in this catalog. Or send your drawing directly to K&B and have it done for you.

Receipt and Installation Made Easy

At your request and for no additional charge, we will mark and box your order so that sections/segments of your system are packed together.

We will also include a single line sketch-drawing of your system showing the pieces and their location.

This will enable you to station boxes closest to the point where they will be needed, thereby eliminating the hassle of locating just the right part in a large delivery.

Ordering Made Easy

Your Representative: (800) 252-3993
Pacific Air Consultants, Inc.
PO Box 426 - 33100 NE Ivy Ave
La Center, WA 98629
www.pacair.net

INDEX	Page
Features	2-3
Clamp Together Duct	
K&B Duct	4
The Forever Clamp	4
Adjustable Sleeve And Additional O-Rings	5
30" Adjustable Sleeve And Sleeve Assemblies	5
Elbows	
Stitched Welded Halves	6
Tubed	6
Gored (Segmented)	7
Pleated/Non-Welded	8
Pleated/Welded	9
Branches - Tee on Taper	10
Branches - Double Branches	10
Branches - Y-Branches	11
In-Cuts	11
Cut-Offs	12
Blast Gates	12
Adapters (To K&B Roll Lip)	12
Hose Adapters	13
Reducers	13
Butterfly Valves	13
Ball Joints	13
Floor Sweeps	13
Transitions	14
Endcaps	14
Steel Flexhose	15
Rubber Flexhose	15
Hose Clamps	15
Special Parts	15
No-Loss Stackheads	16
Bell Mouths	16
Vibration Dampener	16
Radial Arm Hood	16
Back Blast Dampener	16
Hanging Duct	16
Saddles	17
Kwik Hangers	17
Auto. Air Controls	17
Flanged	
Flanged Duct	18
Flanged Elbows	19
Pleated/Non-Welded	20
Pleated/Welded	21
Branches - Tee on Taper	22
Branches - Double Branches	22
Branches - Y-Branches	23
In-Cuts	23
Cut Offs	24
Blast Gates	24
Reducers	24
Transitions	24
Other Components	24
Automatic Air Controls	25
Installation Tips	26-27
Design Instructions	28
Tally Sheet/Order Forms	Center

NEW!

3" and Odd Sizes 11"-19"

K&B Duct provides you with the opportunity to fine tune your duct system for just the right air flows by providing odd sizes in all components.

3"	4"	5"	6"	7"	8"	9"	10"	11"	12"	13"	14"	15"	16"	17"	18"	19"	20"	22"
----	----	----	----	----	----	----	-----	-----	-----	-----	-----	-----	-----	-----	-----	-----	-----	-----

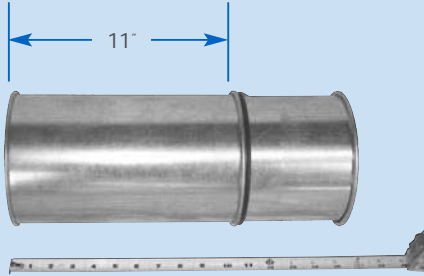

Step 1. For a Sleeve— Cut a standard length of pipe to a length slightly shorter than what you need to make the connections.

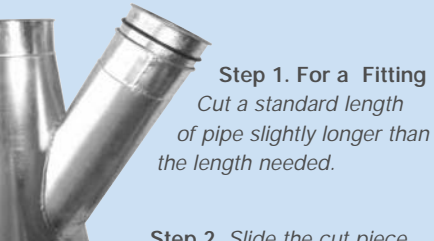

Step 1. For a Fitting
Cut a standard length of pipe slightly longer than the length needed.

Step 2. Slide the cut piece of pipe into the fitting and use an O-ring and clamp to secure the fit.

NEW!

Infinite Adjustment

Infinite Adjustment For Fast Installation

Now you can make infinite adjustments to fit any length requirement. The adjustable sleeve is recommended for longer lengths, and the adjustable collar on ALL fittings are for those short (under 11"), critical and often nagging adjustments between fittings.

NEW!

Adjustment Assemblies

30" Adjustable Sleeves And Sleeve Assemblies

In some cases a longer sleeve is needed to provide for more adjustment. The long adjustable sleeve is 30" long and can provide as much as 26" of adjustment. This is particularly useful where exact measurements are not known in advance.

Sleeve Assemblies can be provided from the factory consisting of a 30" long sleeve, a clamp, O-ring and 30" of pipe. These assemblies require no additional cutting and can be shipped directly to the customer to eliminate the need for field fitting.

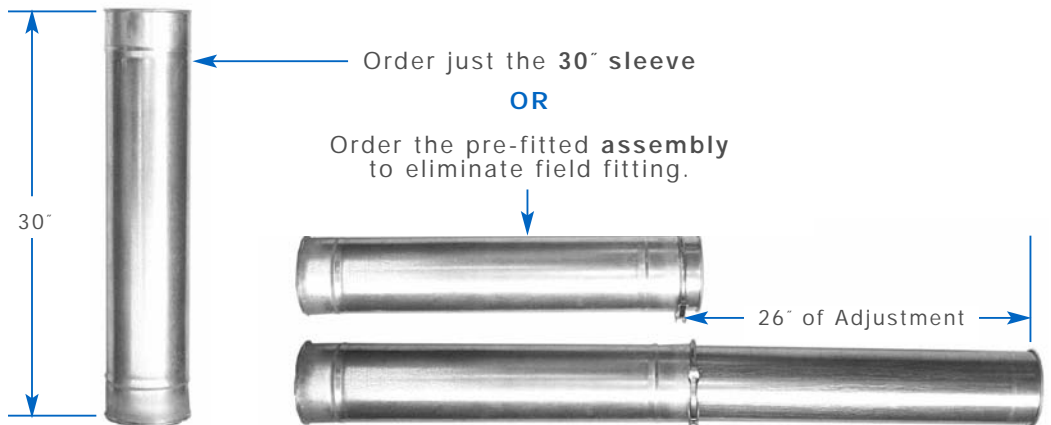

Ordering Made Easy

Your Representative: (800) 252-3993
Pacific Air Consultants, Inc.
PO Box 426 - 33100 NE Ivy Ave
La Center, WA 98629
www.pacair.net

K&B Duct Clamp Together Duct

K-wick GRIP AND HANG 70% faster with K&B Duct's Cable System

- K&B's hanging system is a "K-wick" and simple way to securely suspend ducting from ceilings, beams or other supports. The 'gripper' allows you to form a loop around the duct and then to adjust it to the right length.
- Each package contains 15 feet of cable with a ferruled loop (A) for attaching to the support structure, a "clutcher" (B) to loop the free end around the duct and a release tool (C) that works (as shown in the cutaway view) to release the cable.
- Select from three sizes to fit your application.
- See Page 17 for more details.

NEW!

Heavy Gauge Clamp-Together Duct

K&B Duct can be supplied in gauges up to 10 gauge for abrasive applications.

Where as standard straight duct of sizes 4-18" can be made 1 gauge heavier than the chart for the duct on page 5 shows, there is often a call for even heavier duct. Now K&B Duct is available in heavy gauges from 10 ga and up. In these heavier gauges, the standard collar is applied to seam welded duct or tubing and the end of the duct is flared slightly so that the two ends of heavy gauge material butt up when

clamped together. In the field, adjustment is accomplished by using the standard adjustable sleeve. However, it is always recommended that cuts be made to a closer fit than required with the standard duct so as to limit the exposure of the thinner material to the air stream. Collars can also be supplied for field application in cut to fit scenarios.

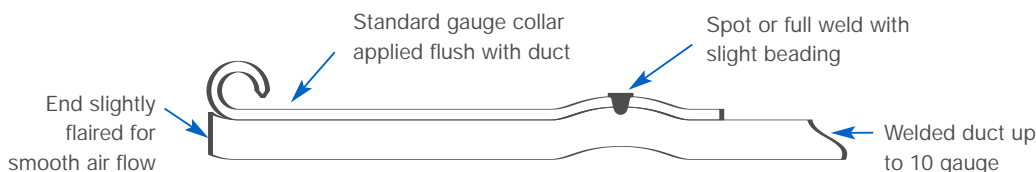

Robust and Tight Fittings

Unless otherwise specified, fittings such as branches (t on tapers), Y's, transitions, reducers and hoods are supplied in 18 gauge. Hard to form areas of the product are fully welded to insure a tight seal. Full welding of the entire part is available upon request however, the standard product is made to tight and stringent specifications. Collars are spot welded AND THEN beaded to make a very tight and secure connection and to create smooth air flow.



The collar is applied to the fitting with spot weld AND THEN beaded to make a tight and secure connection.

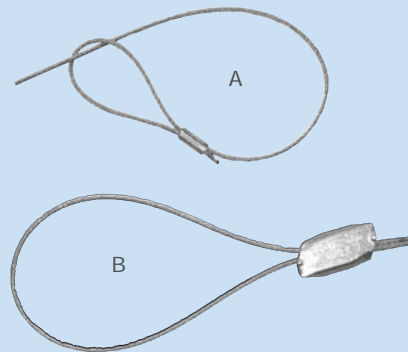
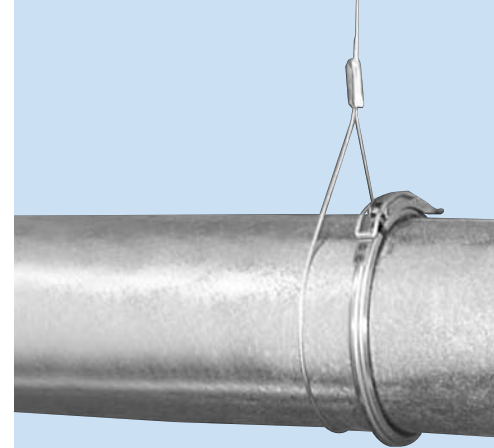

Time is money.

K&B Duct's unique hanging system, featuring our advanced Cable System components, is fast and easy, and saves you time and money.

That's why we call it "K-wick".

Ordering Made Easy

Your Representative: (800) 252-3993
 Pacific Air Consultants, Inc.
 PO Box 426 - 33100 NE Ivy Ave
 La Center, WA 98629
www.pacair.net

NEW!

NOTES:

OTHER GASKET MATERIALS

As needed or requested, other gasket and O-ring materials can be supplied. They are:

RED SILICONE - Used primarily on high heat applications

FDA (white rubber) - Food Grade

VITON - Oil Mist

GORE-TEX- Used in some oil mist applications

All of the above can be supplied as clamp gasket or for the adjustable sleeve/fittings, **HOWEVER**, when needed for the latter, they do not come as a complete O-ring but as a piece of cord. They can still be used as the O-ring but they must be fitted under the clamp.

The Forever Clamp

The all welded stainless steel clamp is fitted with a heavy duty, continuously reusable O-ring sealing gasket. There are no perforations to fatigue or tear. In fact the locking mechanism is so sturdy that it is backed with a "forever" guarantee. **If it ever breaks, tears or becomes unusable, return it for a free replacement. Period.**

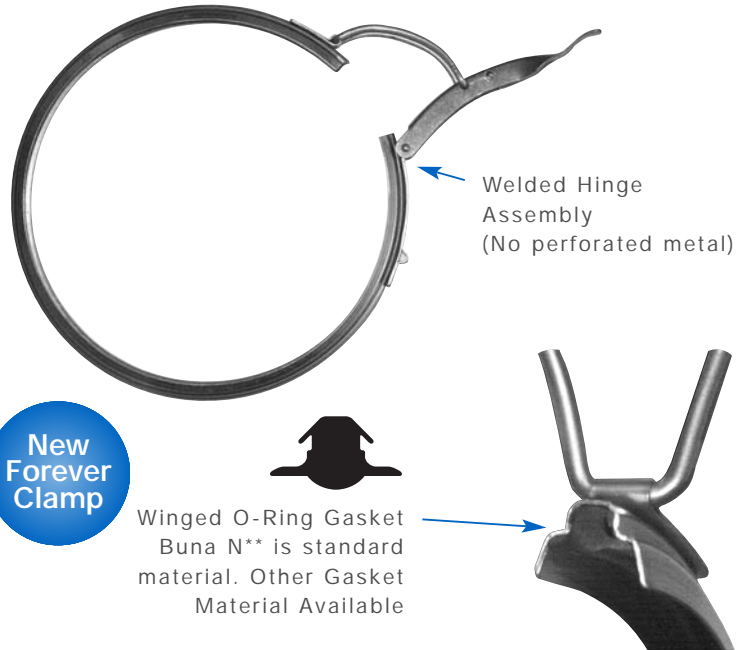

New Forever Clamp

Dia.	Part #
3"	13003
4"	13004
5"	13005
6"	13006
7"	13007
8"	13008
9"	13009
10"	13010
11"	13011
12"	13012
13"	13013
14"	13014
15"	13015
16"	13016
17"	13017
18"	13018
19"	13019
20"	13020
22"	13022

NOTES:

All duct is a nominal 5 feet in length. Sizes 4-18" can be made 1 gauge heavier. 3" duct consist of a 3" collar applied to a 3" piece of rolled duct as opposed to standard duct where the rolled lip is formed on the pipe. The 3" sleeve slides over the pipe as in other sizes.

HEAVY Gauge Duct is constructed with a welded seam and then a standard gauge rolled lip "collar" is welded over the end. The pipe and the collars positioned so that the end of the pipe is flush with the collar. Field adjustment is accomplished by cutting the pipe to exact length and using either a standard adjustable sleeve or welding a new collar to the cut end.

See page 3.

+SS gauge=22

K&B Duct Galvanized and Stainless Steel

Dia.	Part #	Std. Ga.	Hvy. Ga.
3"	10003	26	tubing
4"	10004	24+	tubing
5"	10005	24+	tubing
6"	10006	24+	tubing
7"	10007	22	To 10 ga.
8"	10008	22	To 10 ga.
9"	10009	22	To 10 ga.
10"	10010	22	To 10 ga.
11"	10011	22	To 10 ga.
12"	10012	22	To 10 ga.
13"	10013	20	To 10 ga.
14"	10014	20	To 10 ga.
15"	10015	20	To 10 ga.
16"	10016	20	To 10 ga.
17"	10017	20	To 10 ga.
18"	10018	20	To 10 ga.
19"	10019	20	To 10 ga.
20"	10020	20	To 10 ga.
22"	10022	20	To 10 ga.



5' Lengths

* If using Stainless Steel, add an "SS" to the end of the part #.

K&B Duct Clamp Together Duct

Standard Adjustable Sleeve And Additional O-Rings

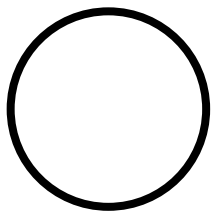
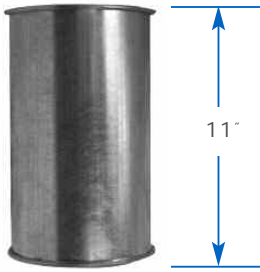

Adjustable Sleeve		Additional O-Ring	
Dia.	Part #	Part #	Hi-Temp
3"	11003	11103	11103HT
4"	11004	11104	11104HT
5"	11005	11105	11105HT
6"	11006	11106	11106HT
7"	11007	11107	11107HT
8"	11008	11108	11108HT
9"	11009	11109	11109HT
10"	11010	11110	11110HT
11"	11011	11111	11111HT
12"	11012	11112	11112HT
13"	11013	11113	11113HT
14"	11014	11114	11114HT
15"	11015	11115	11115HT
16"	11016	11116	11116HT
17"	11017	11117	11117HT
18"	11018	11118	11118HT
19"	11019	11119	11119HT
20"	11020	11120	11120HT
22"	11022	11122	11122HT

* If using Stainless Steel, add an "SS" to the end of the part #.

Special 30" Adjustable Sleeve And Sleeve Assemblies - For Applications Where Cutting Is Not An Option

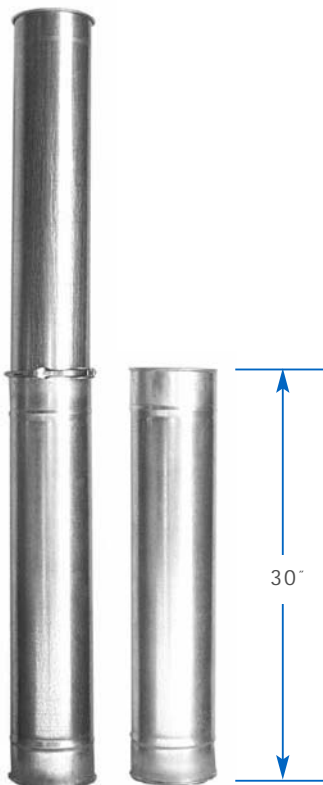

Dia.	30" Sleeve	Sleeve Assembly
	Part #	Part #
3"	11203	11303
4"	11204	11304
5"	11205	11305
6"	11206	11306
7"	11207	11307
8"	11208	11308
9"	11209	11309
10"	11210	11310
11"	11211	11311
12"	11212	11312
13"	11213	11313
14"	11214	11314
15"	11215	11315
16"	11216	11316
17"	11217	11317
18"	11218	11318
19"	11219	11319
20"	11220	11320
22"	11222	11322

* If using Stainless Steel, add an "SS" to the end of the part #.

NOTES:

The 11" adjustable sleeve is the most common method of creating variable lengths of duct in the field. To utilize, cut a standard piece of duct slightly shorter than the needed length. Place O-ring over the cut end and then slide into the 11" sleeve. Once the assembly is adjusted to size, clamp the O-ring to the rolled lip of the sleeve. O-RING IS SUPPLIED WITH 11" SLEEVE.

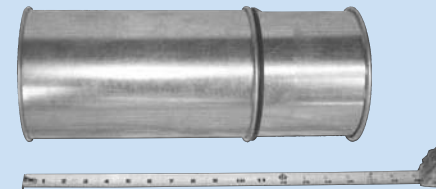

The sleeve is 11" long and therefore the shortest length of adjustment is 11". Additional 'adjustability' for lengths shorter than 11" is provided for in the collars on all fittings. To utilize, simply cut a standard piece of duct slightly longer than the needed length. Place an O-ring over the cut end and slide into the fitting. Once the desired length is obtained, clamp the O-ring to the rolled lip on the fitting. ORDER EXTRA O-RING.

For short (under 11") adjustments



Standard O-ring is made of Buna-N-40 durometer rubber. Highly resistant to most chemicals and oils. Temp rating to 250 degs. Other materials such as Red Silicone, Gore-tex, Viton and FDA rubber are also available in cut to length cord.

- ** 1- O-Ring is supplied with each adjustable sleeve. Additional o-rings may be needed for adjustable fittings such as elbows and branches.
- *** Add "HT" to clamp part number to order High Temp-Other materials are available.

NOTES:

Sleeve is 30" long, The assembly includes sleeve, O-ring, Clamp and a piece of pipe, cut and trimmed to form the pre-fitted assembly. Up to 26" adjustment - 56" total length.

NOTES:

CONSTRUCTION: Available in galvanized only. They are constructed of stamped halves that are then welded with a continuous "stitch" weld that is accomplished by using an inner and outer welding wheel to complete continuous spot welds. The K&B rolled lip collar is spot welded to the elbow and a beader forms the metal so that the ends of the metal are out of the air stream.

APPLICATION: Sizes 3" up to 6" are good for all dust applications. The larger sizes are recommended for light dust or air only as their gauge is not as heavy as those of the other elbows offered.

NOTES:

CONSTRUCTION: Available in Galvanized SS and sizes 3" through 14" (only 3-8" shown in catalog), these are VERY heavy gauge tubing with the standard K&B collar applied in a slip over or into fashion. They are uni-directional.

APPLICATION: While the obvious is that these elbow are used in abrasive application, they are the only offering of SS in the smaller diameters. They also are an additional means of supplying long radius in the smaller diameters and they are the best avenue for a "completely" smooth (no gap) elbow. Interior buffing available for paper trim or fiber applications.

Adjustment Capability



IMPORTANT: When using the adjustable feature of the fitting, order an additional O-ring.

Elbows - Stitched Welded Halves

Standard Radius (1.5)			
Dia.	90 deg	45 deg	GA
	Part #	Part #	
3"	12303.90	12303.45	22
4"	12304.90	12304.45	22
5"	12305.90	12305.45	22
6"	12306.90	12306.45	22
7"	12307.90	12307.45	22
8"	12308.90	12308.45	22
9"	12309.90	12309.45	22
10"	12310.90	12310.45	22
12"	12312.90	12312.45	22



Galvanized Only

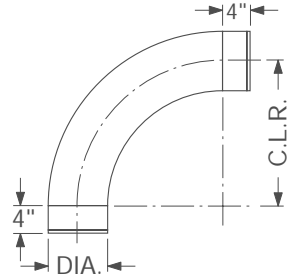

All fittings have slip fit capability in the collar. See page 2.

Tubed Elbows

Standard Radius (1.5)			
Dia.	90 deg	45 deg	GA
	Part #	Part #	
3"	12403.90	12403.45	14
4"	12404.90	12404.45	14
5"	12405.90	12405.45	14
6"	12406.90	12406.45	14
8"	12408.90	12408.45	14
Long Radius (2.5)			
Dia.	90 deg	45 deg	GA
	Part #	Part #	
3"	12403.90L	12403.45L	14
4"	12404.90L	12404.45L	14
5"	12405.90L	12405.45L	14
6"	12406.90L	12406.45L	14
8"	12408.90L	12408.45L	14



Galvanized and Stainless Steel

* If using Stainless Steel, add an "SS" to the end of the part #.

K&B Extensive Elbow Offering

Elbow	Galv	SS	Sizes	Ga.	Radius	Degrees	Air Tight	Particulant	Directional
Stitched 3-6"	•		3-6"	22	1.5	90-45	•	All	
Stitched 7-12"	•		7-12"	22	1.5	90-45	•	Fume-Light Dust	
Tubed	•	•	3-6 & 8"	14	1.5-2.5	90-45	•	All	
Gored	•	•	7" up	20-up	All/Any (1.5-2.5 std)	All (90-60-45-30) std	•	All	
Pleated non-welded	•		3-15"	22-20	1.5-2.5	90-60-45-30	•	Lrg Part.	•
Pleated welded	•		3-15"	22-20	1.5-2.5	90-60-45-30	•	All	•

K&B Duct Clamp Together Duct

Elbows - Gored (Segmented)



Galvanized and Stainless Steel

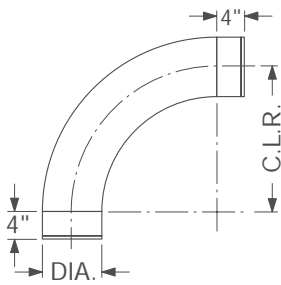

All fittings have slip fit capability in the collar. See page 2.

* If using Stainless Steel, add an "SS" to the end of the part #.

Standard Radius (1.5)*					
	90 deg	60 deg	45 deg	30 deg	
Dia.	Part #	Part #	Part #	Part #	GA
7"	12007.90	12007.60	12007.45	12007.30	20
8"	12008.90	12008.60	12008.45	12008.30	20
9"	12009.90	12009.60	12009.45	12009.30	20
10"	12010.90	12010.60	12010.45	12010.30	20
11"	12011.90	12011.60	12011.45	12011.30	18
12"	12012.90	12012.60	12012.45	12012.30	18
13"	12013.90	12013.60	12013.45	12013.30	18
14"	12014.90	12014.60	12014.45	12014.30	18
15"	12015.90	12015.60	12015.45	12015.30	18
16"	12016.90	12016.60	12016.45	12016.30	18
17"	12017.90	12017.60	12017.45	12017.30	18
18"	12018.90	12018.60	12018.45	12018.30	18
19"	12019.90	12019.60	12019.45	12019.30	18
20"	12020.90	12020.60	12020.45	12020.30	18
22"	12022.90	12022.60	12022.45	12022.30	18
Long Radius (2.5)*					
	90 deg	60 deg	45 deg	30 deg	
Dia.	Part #	Part #	Part #	Part #	GA
7"	12007.90L	12007.60L	12007.45L	12007.30L	20
8"	12008.90L	12008.60L	12008.45L	12008.30L	20
9"	12009.90L	12009.60L	12009.45L	12009.30L	20
10"	12010.90L	12010.60L	12010.45L	12010.30L	20
11"	12011.90L	12011.60L	12011.45L	12011.30L	18
12"	12012.90L	12012.60L	12012.45L	12012.30L	18
13"	12013.90L	12013.60L	12013.45L	12013.30L	18
14"	12014.90L	12014.60L	12014.45L	12014.30L	18
15"	12015.90L	12015.60L	12015.45L	12015.30L	18
16"	12016.90L	12016.60L	12016.45L	12016.30L	18
17"	12017.90L	12017.60L	12017.45L	12017.30L	18
18"	12018.90L	12018.60L	12018.45L	12018.30L	18
19"	12019.90L	12019.60L	12019.45L	12019.30L	18
20"	12020.90L	12020.60L	12020.45L	12020.30L	18
22"	12022.90L	12022.60L	12022.45L	12022.30L	18

NOTES:

CONSTRUCTION: Available in Galvanized or SS. Starting at size 7", the gores (segments) are cut and then formed so that the ends of the gores are locked together. The number of gores varies with the size and angle of the elbow. While radii of 1.5 and 2.5 are shown, they can be made in ANY angle desired. The K&B rolled lip collar is applied as normal.

APPLICATION: Good as all around elbow, providing smooth interior and heavy duty construction. In the event that heavy gauges are needed (greater than 18 ga) the gores are butt welded. The interior can be buffed for paper trim and fiber applications.

The rolled lip collar adds about 2.5" tangent to the length of the elbow. However, please remember that the collar is sized to receive a cut piece of pipe. This provides infinite adjustability.

Adjustment Capability



IMPORTANT: When using the adjustment feature of the fitting, order an additional O-ring. Page 5

Ordering Made Easy

Your Representative: (800) 252-3993
 Pacific Air Consultants, Inc.
 PO Box 426 - 33100 NE Ivy Ave
 La Center, WA 98629
 www.pacair.net

Price Point 1-3 (1=io)	Notes
1	Good all around elbow. Stitch weld halves.
1	Good for fume/light dust/air. Gauge is a little light for heavy dust.
3	Heavy tubed elbow. Only SS elbow in 4-6". These are the only LR 4-6" offered.
2	Good all around elbow. All sizes, all dimensions, all radius over 7". Gores are mechanically locked and caulked. Gauges over 18 will be butt welded.
1	Not air tight - suitable for heavy dust like wood. Made from rolled duct that is pleated/bent into elbow. Pleats close the non-welded end of the rolled duct.
1.5	Good all around elbow. Made from rolled duct that is seam welded and then pleated/bent into elbow.

NOTES:

CONSTRUCTION: These elbows are made by bending and pleating a piece of duct. The NON-Welded style starts with an un-joined piece of duct and as the pleating takes place, the overlapping edges are pressed together on the inside of the elbow. The welded elbow starts with a piece of duct that has been continuously welded down the seam. The duct is formed the same way. The weld is on the outside radius. Both are available in galvanized only.

APPLICATION: The non-welded elbow is a very cost effective elbow used in systems where a small amount of leakage is acceptable. It is uni-directional.

The rolled lip collar adds about 2.5" tangent to the length of the elbow. However, please remember that the collar is sized to receive a cut piece of pipe. This provides infinite adjustability.

Adjustment Capability



IMPORTANT: When using the adjustment feature of the fitting, order an additional O-ring. Page 5

K&B Elbows - Pleated/Non-Welded

Standard Radius (1.5)*					
	90 deg	60 deg	45 deg	30 deg	
Dia.	Part #	Part #	Part #	Part #	GA
3"	12103.90	12103.60	12103.45	12103.30	22
4"	12104.90	12104.60	12104.45	12104.30	22
5"	12105.90	12105.60	12105.45	12105.30	22
6"	12106.90	12106.60	12106.45	12106.30	22
7"	12107.90	12107.60	12107.45	12107.30	22
8"	12108.90	12108.60	12108.45	12108.30	22
9"	12109.90	12109.60	12109.45	12109.30	20
10"	12110.90	12110.60	12110.45	12110.30	20
11"	12111.90	12111.60	12111.45	12111.30	20
12"	12112.90	12112.60	12112.45	12112.30	20
13"	12113.90	12113.60	12113.45	12113.30	20
14"	12114.90	12114.60	12114.45	12114.30	20
15"	12115.90	12115.60	12115.45	12115.30	20
Long Radius (2.5)*					
	90 deg	60 deg	45 deg	30 deg	
Dia.	Part #	Part #	Part #	Part #	GA
3"	12103.90L	12103.60L	12103.45L	12103.30L	22
4"	12104.90L	12104.60L	12104.45L	12104.30L	22
5"	12105.90L	12105.60L	12105.45L	12105.30L	22
6"	12106.90L	12106.60L	12106.45L	12106.30L	22
7"	12107.90L	12107.60L	12107.45L	12107.30L	22
8"	12108.90L	12108.60L	12108.45L	12108.30L	22
9"	12109.90L	12109.60L	12109.45L	12109.30L	20
10"	12110.90L	12110.60L	12110.45L	12110.30L	20
11"	12111.90L	12111.60L	12111.45L	12111.30L	20
12"	12112.90L	12112.60L	12112.45L	12112.30L	20
13"	12113.90L	12113.60L	12113.45L	12113.30L	20
14"	12114.90L	12114.60L	12114.45L	12114.30L	20
15"	12115.90L	12115.60L	12115.45L	12115.30L	20



Galvanized Only

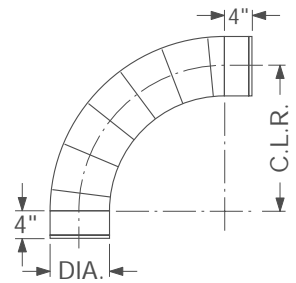

All fittings have slip fit capability in the collar. See page 2.

Ordering Made Easy

Your Representative: (800) 252-3993
 Pacific Air Consultants, Inc.
 PO Box 426 - 33100 NE Ivy Ave
 La Center, WA 98629
 www.pacair.net

K&B Duct Clamp Together Duct

K&B Elbows - Pleated/Welded

Standard Radius (1.5)					
Dia.	90 deg	60 deg	45 deg	30 deg	GA
	Part #	Part #	Part #	Part #	
3"	12203.90	12203.60	12203.45	12203.30	22
4"	12204.90	12204.60	12204.45	12204.30	22
5"	12205.90	12205.60	12205.45	12205.30	22
6"	12206.90	12206.60	12206.45	12206.30	22
7"	12207.90	12207.60	12207.45	12207.30	22
8"	12208.90	12208.60	12208.45	12208.30	22
9"	12209.90	12209.60	12209.45	12209.30	20
10"	12210.90	12210.60	12210.45	12210.30	20
11"	12211.90	12211.60	12211.45	12211.30	20
12"	12212.90	12212.60	12212.45	12212.30	20
13"	12213.90	12213.60	12213.45	12213.30	20
14"	12214.90	12214.60	12214.45	12214.30	20
15"	12215.90	12215.60	12215.45	12215.30	20
Long Radius (2.5)					
Dia.	90 deg	60 deg	45 deg	30 deg	GA
	Part #	Part #	Part #	Part #	
3"	12203.90L	12203.60L	12203.45L	12203.30L	22
4"	12204.90L	12204.60L	12204.45L	12204.30L	22
5"	12205.90L	12205.60L	12205.45L	12205.30L	22
6"	12206.90L	12206.60L	12206.45L	12206.30L	22
7"	12207.90L	12207.60L	12207.45L	12207.30L	22
8"	12208.90L	12208.60L	12208.45L	12208.30L	22
9"	12209.90L	12209.60L	12209.45L	12209.30L	20
10"	12210.90L	12210.60L	12210.45L	12210.30L	20
11"	12211.90L	12211.60L	12211.45L	12211.30L	20
12"	12212.90L	12212.60L	12212.45L	12212.30L	20
13"	12213.90L	12213.60L	12213.45L	12213.30L	20
14"	12214.90L	12214.60L	12214.45L	12214.30L	20
15"	12215.90L	12215.60L	12215.45L	12215.30L	20



Galvanized Only

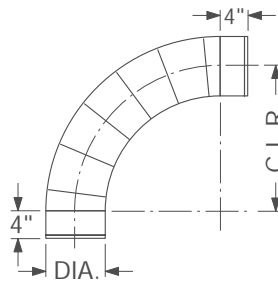

All fittings have slip fit capability in the collar. See page 2.

NOTES:

CONSTRUCTION: These elbows are made by bending and pleating a piece of duct. The NON-Welded style starts with an un-joined piece of duct and as the pleating takes place, the overlapping edges are pressed together on the inside of the elbow. The welded elbow starts with a piece of duct that has been continuously welded down the seam. The duct is formed the same way but the weld is on the outside radius.

APPLICATION: The welded elbow provides good all around usage. It is uni-directional.

The rolled lip collar adds about 2.5" tangent to the length of the elbow. However, please remember that the collar is sized to receive a cut piece of pipe. This provides infinite adjustability.

Adjustment Capability



IMPORTANT: When using the adjustment feature of the fitting, order an additional O-ring. Page 5

Ordering Made Easy

Your Representative: (800) 252-3993
 Pacific Air Consultants, Inc.
 PO Box 426 - 33100 NE Ivy Ave
 La Center, WA 98629
www.pacair.net

NOTES:

STANDARD CONSTRUCTION is 18 ga with the branch fully welded to the taper. The back of the taper is lapped spot welded and caulked. The 2.5" collar is applied as shown on page 3. Length of branch varies based upon the various dimensions. However, REMEMBER, that length is not important in designing because of the adjustability of the system. IE the cut pipe can slide into the collar to adjust the length.

Heavier gauges and full welded are available.

IMPORTANT: When using the adjustable feature of the fitting, order an additional O-ring. See page 2.

Adjustment Capability



IMPORTANT: When using the adjustment feature of the fitting, order an additional O-ring. Page 5

Branches (Tee on Taper)

Dia.	Part #	Part #	Part #	GA
	30 deg	45 deg	Tee'	
3"	14003.30	14003.45	14303	18
4"	14004.30	14004.45	14304	18
5"	14005.30	14005.45	14305	18
6"	14006.30	14006.45	14306	18
7"	14007.30	14007.45	14307	18
8"	14008.30	14008.45	14308	18
9"	14009.30	14009.45	14309	18
10"	14010.30	14010.45	14310	18
11"	14011.30	14011.45	14311	18
12"	14012.30	14012.45	14312	18
13"	14013.30	14013.45	14313	18
14"	14014.30	14014.45	14314	18
15"	14015.30	14015.45	14315	18
16"	14016.30	14016.45	14316	18
17"	14017.30	14017.45	14317	18
18"	14018.30	14018.45	14318	18
19"	14019.30	14019.45	14319	18
20"	14020.30	14020.45	14320	18
22"	14022.30	14022.45	14322	18

* If using Stainless Steel, add an "SS" to the end of the part #.

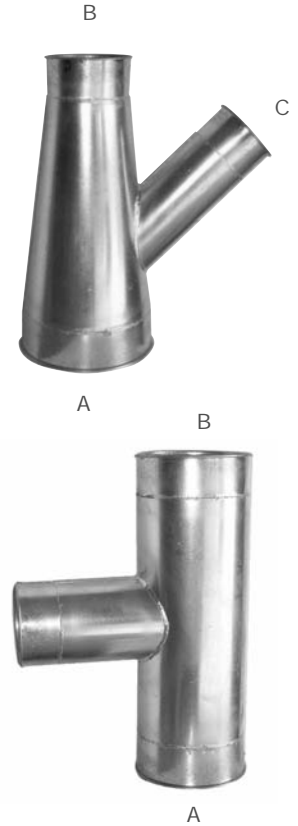

Galvanized and Stainless Steel

Double Branches

Dia.	Part #	Part #	GA
	30 deg	45 deg	
3"	14103.30	14103.45	18
4"	14104.30	14104.45	18
5"	14105.30	14105.45	18
6"	14106.30	14106.45	18
7"	14107.30	14107.45	18
8"	14108.30	14108.45	18
9"	14109.30	14109.45	18
10"	14110.30	14110.45	18
11"	14111.30	14111.45	18
12"	14112.30	14112.45	18
13"	14113.30	14113.45	18
14"	14114.30	14114.45	18
15"	14115.30	14115.45	18
16"	14116.30	14116.45	18
17"	14117.30	14117.45	18
18"	14118.30	14118.45	18
19"	14119.30	14119.45	18
20"	14120.30	14120.45	18
22"	14122.30	14122.45	18

* If using Stainless Steel, add an "SS" to the end of the part #.

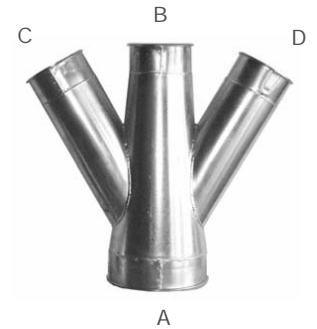

Galvanized and Stainless Steel

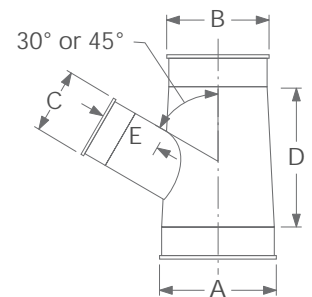

$D = (2 \times C) + 6"$ or A which ever is larger.
Add 2.5" for each collar.

C	E
4"-12"	8.5"
13"-18"	11.5"
19" up	14.5"

K&B Duct Clamp Together Duct

Y-Branches

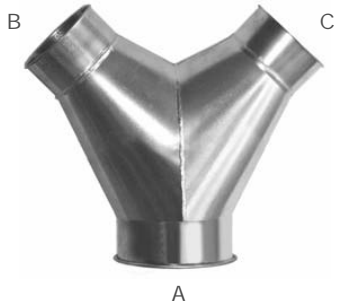

Galvanized and Stainless Steel

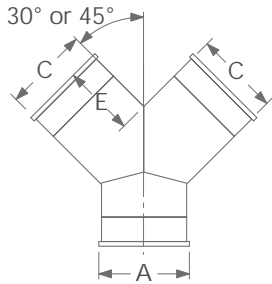

All fittings have slip fit capability in the collar. See page 3.

C	E
4"-12"	8.5"
13"-18"	11.5"
19" up	14.5"

Dia.	Part #	Part #	GA
	30 deg	45 deg	
4"	14204.30	14204.45	18
5"	14205.30	14205.45	18
6"	14206.30	14206.45	18
7"	14207.30	14207.45	18
8"	14208.30	14208.45	18
9"	14209.30	14209.45	18
10"	14210.30	14210.45	18
11"	14211.30	14211.45	18
12"	14212.30	14212.45	18
13"	14213.30	14213.45	18
14"	14214.30	14214.45	18
15"	14215.30	14215.45	18
16"	14216.30	14216.45	18
17"	14217.30	14217.45	18
18"	14218.30	14218.45	18
19"	14219.30	14219.45	18
20"	14220.30	14220.45	18
22"	14222.30	14222.45	18

* If using Stainless Steel, add an "SS" to the end of the part #.

In-Cuts

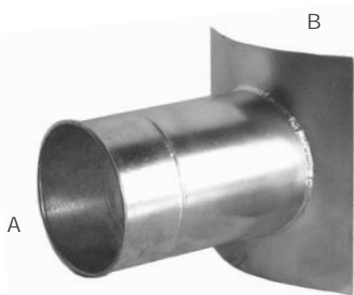

Galvanized and Stainless Steel

Dia.	Part #	Part #	Part #	GA
	30 deg	45 deg	T's	
3"	14403.30	14403.45	14503	18
4"	14404.30	14404.45	14504	18
5"	14405.30	14405.45	14505	18
6"	14406.30	14406.45	14506	18
7"	14407.30	14407.45	14507	18
8"	14408.30	14408.45	14508	18
9"	14409.30	14409.45	14509	18
10"	14410.30	14410.45	14510	18
11"	14411.30	14411.45	14511	18
12"	14412.30	14412.45	14512	18
13"	14413.30	14413.45	14513	18
14"	14414.30	14414.45	14514	18
15"	14415.30	14415.45	14515	18
16"	14416.30	14416.45	14516	18
17"	14417.30	14417.45	14517	18
18"	14418.30	14418.45	14518	18
19"	14419.30	14419.45	14519	18
20"	14420.30	14420.45	14520	18
22"	14422.30	14422.45	14522	18

* If using Stainless Steel, add an "SS" to the end of the part #.

NOTES:

STANDARD CONSTRUCTION is 18 ga. (The taper is lapped spot welded and caulked. The halves are then full welded together.) The 2.5" collar is applied as standard. Length of Y branch varies based upon the various dimensions. However, REMEMBER, that length is not important in designing because of the adjustability of the system. IE the cut pipe can slide into the collar to adjust the length. Angle rings or flanges can be applied to the transitions and adapters to mate with existing duct, or they can be made with raw ends sized to specific dimensions.

Heavier gauges are available.

NOTES:

In cuts are designed for quick introduction of a lateral line to an existing trunk line. They are sized by the lateral. Construction and dimensions of the lateral is the same as a branch.

Adjustment Capability



IMPORTANT: When using the adjustment feature of the fitting, order an additional O-ring. Page 5

Ordering Made Easy

Your Representative: (800) 252-3993
Pacific Air Consultants, Inc.
PO Box 426 - 33100 NE Ivy Ave
La Center, WA 98629
www.pacair.net

NOTES:

Construction: The standard FULL cut off is an aluminum cast housing to which collars have been "screwed". The screw is then ground off on the inside to keep it out of the air stream. The HALF GATE is simply the housing and gate with no collars. It is attached to existing duct by cutting a slit and sliding the gate over the duct. It can be attached to existing duct with screws. It is shown installed.

Application: cut offs are used primarily to cut off air supply to areas when dust collection/ venting is not needed. This can improve performance in other areas or simply limit the size of the needed collector. It is difficult to design a "balanced" system incorporating cut offs as the dynamics of the system are changing.

Blast Gates are used primarily where air is bled into the system or where heavier application of air diverting is required. They are air tight and fully welded.

SS Cut-offs are cast aluminum bodies and SS blades and collars.

IMPORTANT: When using the adjustable feature of the fitting, order an additional O-ring. See page 2.

NOTES:

Adapters can be made to fit ANY AND ALL existing duct, hood connections, valves, gates, etc, etc, etc. The non-rolled end can be fitted with a flange, expanded out, or pulled in to fit specified dimension. Adaptations requiring greater than 1/8" increase or decrease from given size will be priced as a reducer.

+SS Gauge = 22

Cut-Offs

Dia.	Part #	Part #
	FULL	HALF
3"	18003	18103
4"	18004	18104
5"	18005	18105
6"	18006	18106
7"	18007	18107
8"	18008	18108
9"	18009	18109
10"	18010	18110
11"	18011	18111
12"	18012	18112
14"	18014	18114
16"	18016	18116
18"	18018	18118
20"	18020	N/A
22"	18022	N/A



Blades In Galvanized and Stainless Steel

Blast Gates - Air Tight

Dia.	Part #	GA
3"	18203	14
4"	18204	14
5"	18205	14
6"	18206	14
7"	18207	14
8"	18208	14
9"	18209	14
10"	18210	14
11"	18211	14
12"	18212	14
13"	18213	14
14"	18214	14
15"	18215	14
16"	18216	14
17"	18217	14
18"	18218	14
19"	18219	14
20"	18220	14
22"	18222	14



Galvanized and Stainless Steel

* If using Stainless Steel, add an "SS" to the end of the part #.

Adapters (To K&B Rolled Lip)

Dia.	STRAIGHT (non flanged)	FLANGED	GA
	Part #	Part #	
3"	15003	15103	24+
4"	15004	15104	24+
5"	15005	15105	24+
6"	15006	15106	24+
7"	15007	15107	22
8"	15008	15108	22
9"	15009	15109	22
10"	15010	15110	22
11"	15011	15111	22
12"	15012	15112	22
13"	15013	15113	20
14"	15014	15114	20
15"	15015	15115	20
16"	15016	15116	20
7"	15017	15117	20
8"	15018	15118	20
9"	15019	15119	20
0"	15020	15120	20
2"	15022	15122	20



Galvanized and Stainless Steel

* If using Stainless Steel, add an "SS" to the end of the part #.

Ordering Made Easy

Your Representative: (800) 252-3993
 Pacific Air Consultants, Inc.
 PO Box 426 - 33100 NE Ivy Ave
 La Center, WA 98629
 www.pacair.net

K&B Duct Clamp Together Duct

Hose Adapters

Dia.	Part#	GA
3"	15203	24+
4"	15204	24+
5"	15205	24+
6"	15206	24+
7"	15207	22
8"	15208	22
9"	15209	22
10"	15210	22
11"	15211	22
12"	15212	22
13"	15213	20
14"	15214	20
15"	15215	20
16"	15216	20
17"	15217	20
18"	15218	20
19"	15219	20
20"	15220	20
22"	15222	20



Galvanized and Stainless Steel

Reducers

Dia.	Part #	GA
3"	16003	20
4"	16004	20
5"	16005	20
6"	16006	20
7"	16007	20
8"	16008	20
9"	16009	20
10"	16010	20
11"	16011	20
12"	16012	20
13"	16013	20
14"	16014	20
15"	16015	20
16"	16016	20
17"	16017	20
18"	16018	20
19"	16019	20
20"	16020	20
22"	16022	20



Galvanized and Stainless Steel

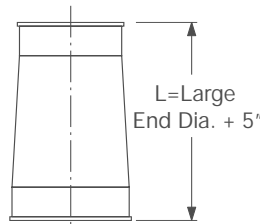

All fittings have slip fit capability in the collar. See page 3.

NOTES:

STANDARD CONSTRUCTION for reducer is 18 ga. The taper is lapped spot welded and caulked. The 2.5" collar is applied as standard. Length of reducer varies based upon the various dimensions. However, **REMEMBER**, that length is not important in designing because of the adjustability of the system. IE the cut pipe can slide into the collar to adjust the length.

Sized and price by large end. Specify dimension, A (large end) to B (small end).

Heavier gauges and full welded are available.

Reducers are priced by large end.

IMPORTANT: When using the adjustable feature of the fitting, order an additional O-ring. See page 2.

+SS gauge=22

Adjustment Capability

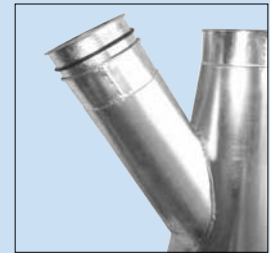

IMPORTANT: When using the adjustment feature of the fitting, order an additional O-ring. Page 5

* If using Stainless Steel, add an "SS" to the end of the part #.

Butterfly Valves

Dia.	Part #	GA
3"	19403	24+
4"	19404	24+
5"	19405	24+
6"	19406	24+
7"	19407	22
8"	19408	22
9"	19409	22
10"	19410	22
11"	19411	22
12"	19412	22
13"	19413	20
14"	19414	20
15"	19415	20
16"	19416	20
17"	19417	20
18"	19418	20
19"	19419	20
20"	19420	20
22"	19422	20



Galvanized and Stainless Steel

Ball Joints

Dia.	Part #
3"	19303
4"	19304
5"	19305
6"	19306
7"	19307
8"	19308
9"	19309
10"	19310
11"	19311
12"	19312



Galvanized Only

Floor Sweeps

Dia.	Part #	GA
4"	19004	18
5"	19005	18
6"	19006	18
7"	19007	18
8"	19008	18



Galvanized and Stainless Steel

NOTES:

BUTTERFLY VALVES are used primarily for controlling and balancing air flows and draft.

BALL JOINTS are of spun metal and rotate freely in all directions. Perfect for machines with moving heads such as CNC routers

FLOOR SWEEPS are fully welded and seal when closed. Ideal in machining operations where dust is hard to capture.

+SS gauge=22

* If using Stainless Steel, add an "SS" to the end of the part #.

NOTES:

STANDARD CONSTRUCTION is 18 ga. The taper is lapped spot welded and caulked. The 2.5" collar is applied as standard. Length varies based upon the various dimensions. However, REMEMBER, that length is not important in designing because of the adjustability of the system. IE the cut pipe can slide into the collar to adjust the length. Angle rings or flanges can be applied to the transitions and adapters to mate with existing duct, or they can be made with raw ends sized to specific dimensions.

Heavier gauges and full welded are available.

IMPORTANT: When using the adjustable feature of the fitting, order an additional O-ring. See page 2.

Rectangular to Round Transitions

Dia.	Hemmed	Rect Flange End	GA
	Part #	Part #	
3"	16103	16203	20
4"	16104	16204	20
5"	16105	16205	20
6"	16106	16206	20
7"	16107	16207	20
8"	16108	16208	20
9"	16109	16209	20
10"	16110	16210	20
11"	16111	16211	20
12"	16112	16212	20
13"	16113	16213	20
14"	16114	16214	20
15"	16115	16215	18
16"	16116	16216	18
17"	16117	16217	18
18"	16118	16218	18
19"	16119	16219	18
20"	16120	16220	18
22"	16122	16222	18

*If using Stainless Steel, add an "SS" to the end of the part #.



Galvanized and Stainless Steel

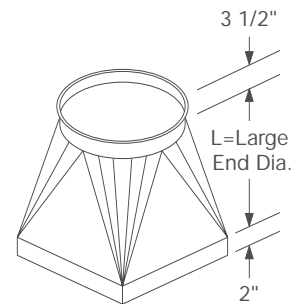

All fittings have slip fit capability in the collar. See page 3.

Endcaps

Dia.	CLOSED END	BIRD SCREEN
	Part #	Part #
3"	19503	19604
4"	19504	19604
5"	19505	19605
6"	19506	19606
7"	19507	19607
8"	19508	19608
9"	19509	19609
10"	19510	19610
11"	19511	19611
12"	19512	19612
13"	19513	19613
14"	19514	19614
15"	19515	19615
16"	19516	19616
17"	19517	19617
18"	19518	19618
19"	19519	19619
20"	19520	19620
22"	19522	19622



Galvanized and Stainless Steel

Ordering Made Easy

Your Representative: (800) 252-3993
 Pacific Air Consultants, Inc.
 PO Box 426 - 33100 NE Ivy Ave
 La Center, WA 98629
 www.pacair.net

K&B Duct Clamp Together Duct

Steel Flex Hoses

	RIGID	FLEXIBLE
Dia.	Part #	Part #
2"	18502	
2.5"	18502.5	
3"	18503	18603
4"	18504	18604
5"	18505	18605
6"	18506	18606
7"	18507	18607
8"	18508	18608
9"	18509	
10"	18510	
12"	18512	



Rubber Flex Hoses

Dia.	Black	Clear
	Part #	Part #
2"	18302	18402
2.5"	18302.5	18402.5
3"	18303	18403
4"	18304	18404
5"	18305	18405
6"	18306	18406
7"	18307	18407
8"	18308	18408
9"	18309	
10"	18310	18410
12"	18312	18412
14"	18314	18414
16"	18316	18416
18"	18318	18418
20"	18320	
24"	18324	

Hose Clamps

Dia.	Part #
2"	17202
3"	17203
4"	17204
5"	17205
6"	17206
8"	17208
10"	17210
12"	17212

Special Parts



Diverter Valves



Viewing Spools



Router Hoods



Suction Hoods

NOTES:

Other types of hoses are available.

Steelflex comes in two types: Rigid flex which holds the contour to which it is moved; flexible which moves freely like rubber hose.

NOTES:

Special Components. Virtually any standard component and any special component can be fabricated to meet the customer's specification. Send your drawing or contact K&B for additional information.

Ordering Made Easy

Your Representative: (800) 252-3993
 Pacific Air Consultants, Inc.
 PO Box 426 - 33100 NE Ivy Ave
 La Center, WA 98629
www.pacair.net

NOTES:

No Loss Stack Heads are designed for roof top exhaust while eliminating the pressure drops associated with other "caps" and vent tops.

Bell mouths make great hoods because of the graduated curve of the metal.

Vibration Dampeners with their rubber insert, effectively separate fans from the duct and eliminate vibration from the fan being transmitted to the duct.

Radial Arm hoods come with flared sides to better capture the dust typically "thrown" by a radial arm saw.

No Loss Stack Heads

Dia.	Part #	GA.
4"	19204	24
5"	19205	24
6"	19206	24
7"	19207	22
8"	19208	22
9"	19209	22
10"	19210	22
11"	19211	22
12"	19212	22
13"	19213	20
14"	19214	20
15"	19215	20
16"	19216	20
17"	19217	20
18"	19218	20
19"	19219	20
20"	19220	20
22"	19222	20



Bell Mouths

Dia.	Part #	GA
4"	16304	18
5"	16305	18
6"	16306	18
7"	16307	18
8"	16308	18
9"	16309	18
10"	16310	18
11"	16311	18
12"	16312	18
13"	16313	18
14"	16314	18
15"	16315	18
16"	16316	18
17"	16317	18
18"	16318	18
19"	16319	18
20"	16320	18
22"	16322	18



In-Line Back Blast

Dia.	Part #	GA
4"	11504	18
5"	11505	18
6"	11506	18
7"	11507	18
8"	11508	18
9"	11509	18
10"	11510	18
11"	11511	18
12"	11512	18
13"	11513	18
14"	11514	18
15"	11515	18
16"	11516	18
17"	11517	18
18"	11518	18
19"	11519	16
20"	11520	16
22"	11522	16
24"	11524	16
26"	11526	16
28"	11528	16
30"	11530	16
32"	11532	16
34"	11534	16

Vibration Dampeners

Dia.	Part #	GA
4"	15404	20
5"	15405	20
6"	15406	20
7"	15407	20
8"	15408	20
9"	15409	20
10"	15410	20
12"	15412	20
14"	15414	20
16"	15416	20
18"	15418	20
20"	15420	20
22"	15422	20
24"	15424	20
26"	15426	20
28"	15428	20
30"	15430	20



**If using Stainless Steel, add an "SS" to the end of the part #.*

Radial Arm Hoods

Dia.	Part #	GA
4"	19104	18
5"	19105	18
6"	19106	18



Ordering Made Easy

Your Representative: (800) 252-3993
 Pacific Air Consultants, Inc.
 PO Box 426 - 33100 NE Ivy Ave
 La Center, WA 98629
 www.pacair.net

K&B Duct Hanging System

Hanging Duct

Hanging duct can be accomplished with a variety of methods ranging from cable hangers to duct saddles and treaded rod/conduit. The important thing to consider is the spacing of the hangers. Spacing is NOT dictated by the duct but rather by the weight of the material to be collected and the collective weight of the dust and duct should the duct become "plugged". To calculate this, simply multiply the area (A) of the duct by the length of the duct. $A = \pi r^2$ times the length. Then using the weight

capacity of the hanger, space according to the worst case scenario. For example: A 1' section of 18" duct would have a volume of $(3.14 \times (9 \times 9) \times 12) / (1728)$ to give you the cubic feet answer of 1.76. If your collected dust = 15 lbs per cubic foot, then your potential break load would have to be 26 lbs/foot of duct. Using the chart at the bottom, a #3 hanger would be more than adequate as it is recommended that duct be suspended at least every 15' for rigidity.

Saddles

Dia.	Part #	GA
4"	17004	16
5"	17005	16
6"	17006	16
7"	17007	16
8"	17008	16
9"	17009	16
10"	17010	16
11"	17011	14
12"	17012	14
13"	17013	14
14"	17014	14
15"	17015	14
16"	17016	14
17"	17017	14
18"	17018	14
19"	17019	14
20"	17020	14
22"	17022	14

ADDITIONAL HANGING ACCESSORIES

- Threaded Rod
- Ceiling Clips
- Pig Tail Anchor Bolts
- Conduit



NOTES:

K&B Duct offers saddle hangers, threaded rod and conduit for the hanging of duct. The saddle hangers encompass the duct and are bolted together. Threaded rod or electrical conduit can then be used. Threaded rod is simply used as the bolt for the saddle. With conduit, the ends must be hammered flat and drilled so that the bolt used on the saddle will also secure the conduit.

"K-wik" Hangers

Size	#3			#4			#5		
	0*	30*	45*	0*	30*	45*	0*	30*	45*
Working Loads (lbs)	176	151	123	495	425	346	715	614	500
Break Loads (lbs)	1276			3300			4752		
Part No.	17100.3			17100.4			17100.5		

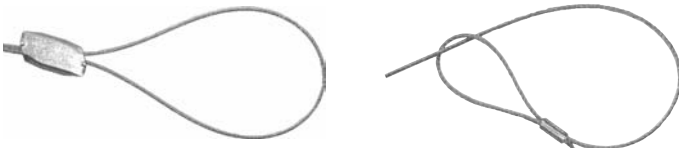

Each package contains cable, and clutcher
Cables available in 15'-30'

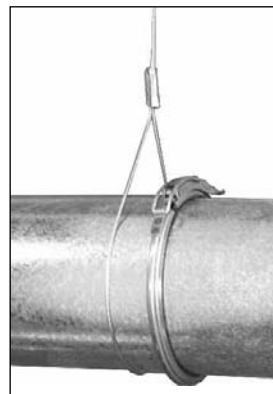

NOTES:

Cable hangers are a quick and secure way to suspend duct. It is an especially good system to use during installation. They can be used exclusively or if a more rigid system is required, they can be interspersed with more rigid hangers.

Hangers must be selected and spaced based upon the weight of the DUCT AND MATERIAL being conveyed assuming worst case (plugged) scenario. K&B Duct is not liable for consequential or incidental damages related to this product. There are no warranties expressed or implied.

NOTES:

Flanged duct is available in 5' or 10' lengths. It is also available fully seam welded or in lock seamed joints. Lock seamed is only available in 5'.

Standard flanges are galvanized. Available also in stainless steel or black iron.

+SS gauge=22

Available in heavier gauges and larger sizes. Call for pricing.

Flange Duct

Flange Duct (with flanges)			Flanges (Individual)
Dia.	Part #	GA	Part #
4"	20004	24+	23004
5"	20005	24+	23005
6"	20006	24+	23006
7"	20007	22	23007
8"	20008	22	23008
9"	20009	22	23009
10"	20010	22	23010
11"	20011	22	23011
12"	20012	22	23012
13"	20013	20	23013
14"	20014	20	23014
15"	20015	20	23015
16"	20016	20	23016
17"	20017	20	23017
18"	20018	20	23018
19"	20019	20	23019
20"	20020	20	23020
22"	20022	20	23022
24"	20024	18	23024
26"	20026	18	23026
28"	20028	18	23028
30"	20030	18	23030
32"	20032	18	23032
34"	20034	18	23034
36"	20036	18	23036
38"	20038	18	23038
40"	20040	18	23040
42"	20042	16	23042
44"	20044	16	23044
46"	20046	16	23046
48"	20048	16	23048



Galvanized and Stainless Steel



*If using Stainless Steel, add an "SS" to the end of the part #.

Ordering Made Easy

Your Representative: (800) 252-3993
 Pacific Air Consultants, Inc.
 PO Box 426 - 33100 NE Ivy Ave
 La Center, WA 98629
 www.pacair.net

K&B Duct Flanged Duct

Elbows - Flanged

Standard Radius (1.5)					
	90 deg	60 deg	45 deg	30 deg	
Dia.	Part #	Part #	Part #	Part #	GA
See note for sizes under 24".					
24"	22024.90	22024.60	22024.45	22024.30	18
26"	22026.90	22026.60	22026.45	22026.30	18
32"	22032.90	22032.60	22032.45	22032.30	16
34"	22034.90	22034.60	22034.45	22034.30	16
36"	22036.90	22036.60	22036.45	22036.30	16
38"	22038.90	22038.60	22038.45	22038.30	16
40"	22040.90	22040.60	22040.45	22040.30	16
42"	22042.90	22042.60	22042.45	22042.30	16
44"	22044.90	22044.60	22044.45	22044.30	16
46"	22046.90	22046.60	22046.45	22046.30	16
48"	22048.90	22048.60	22048.45	22048.30	16
Long Radius (2.5)					
	90 deg	60 deg	45 deg	30 deg	
Dia.	Part #	Part #	Part #	Part #	GA
See note for sizes under 24".					
24"	22024.0L	22024.0L	22024.45L	22024.0L	18
26"	22026.0L	22026.0L	22026.45L	22026.0L	18
28"	22028.0L	22028.0L	22028.45L	22028.0L	18
30"	22030.0L	22030.0L	22030.45L	22030.0L	16
32"	22032.0L	22032.0L	22032.45L	22032.0L	16
34"	22034.0L	22034.0L	22034.45L	22034.0L	16
36"	22036.0L	22036.0L	22036.45L	22036.0L	16
38"	22038.0L	22038.0L	22038.45L	22038.0L	16
40"	22040.0L	22040.0L	22040.45L	22040.0L	16
42"	22042.0L	22042.0L	22042.45L	22042.0L	16
44"	22044.0L	22044.0L	22044.45L	22044.0L	16
46"	22046.0L	22046.0L	22046.45L	22046.0L	16
48"	22048.0L	22048.0L	22048.45L	22048.0L	16

*If using Stainless Steel, add an "SS" to the end of the part #.



Galvanized and Stainless Steel



NOTES:

For parts under 24" use the price of the corresponding part in the K&B Duct line and add the price of two flanges.

To create the part # simply change the first number in the K&B Duct part # from a "1" to a "2". This will signify that the part is to be flanged.

Available in heavier gauges and larger sizes. Call for pricing.

Ordering Made Easy

Your Representative: (800) 252-3993
 Pacific Air Consultants, Inc.
 PO Box 426 - 33100 NE Ivy Ave
 La Center, WA 98629
www.pacair.net

NOTES:

CONSTRUCTION: These elbows are made by bending and pleating a piece of duct. The NON-Welded style starts with an un-joined piece of duct and as the pleating takes place, the overlapping edges are pressed together on the inside of the elbow. The welded elbow starts with a piece of duct that has been continuously welded down the seam. The duct is formed the same way. The weld is on the outside radius. Both are available in galvanized only.

APPLICATION: The non-welded elbow is a very cost effective elbow used in systems where a small amount of leakage is acceptable ie the wood industry. The welded elbow provides good all around usage. Both are uni-directional.

K&B Elbows - Flanged Pleated/Non-Welded

Standard Radius (1.5)					
	90 deg	60 deg	45 deg	30 deg	
Dia.	Part #	Part #	Part #	Part #	GA
4"	22104.90	22104.60	22104.45	22104.30	22
5"	22105.90	22105.60	22105.45	22105.30	22
6"	22106.90	22106.60	22106.45	22106.30	22
7"	22107.90	22107.60	22107.45	22107.30	22
8"	22108.90	22108.60	22108.45	22108.30	22
9"	22109.90	22109.60	22109.45	22109.30	20
10"	22110.90	22110.60	22110.45	22110.30	20
11"	22111.90	22111.60	22111.45	22111.30	20
12"	22112.90	22112.60	22112.45	22112.30	20
13"	22113.90	22113.60	22113.45	22113.30	20
14"	22114.90	22114.60	22114.45	22114.30	20
15"	22115.90	22115.60	22115.45	22115.30	20
Long Radius (2.5)					
	90 deg	60 deg	45 deg	30 deg	
Dia.	Part #	Part #	Part #	Part #	GA
4"	22104.90L	22104.60L	22104.45L	22104.30L	22
5"	22105.90L	22105.60L	22105.45L	22105.30L	22
6"	22106.90L	22106.60L	22106.45L	22106.30L	22
7"	22107.90L	22107.60L	2107.45L	22107.30L	22
8"	22108.90L	22108.60L	22108.45L	22108.30L	22
9"	22109.90L	22109.60L	22109.45L	22109.30L	20
10"	22110.90L	22110.60L	22110.45L	22110.30L	20
11"	22111.90L	22111.60L	22111.45L	22111.30L	20
12"	22112.90L	22112.60L	22112.45L	22112.30L	20
13"	22113.90L	22113.60L	22113.45L	22113.30L	20
14"	22114.90L	22114.60L	22114.45L	22114.30L	20



Galvanized Only



Ordering Made Easy

Your Representative: (800) 252-3993
 Pacific Air Consultants, Inc.
 PO Box 426 - 33100 NE Ivy Ave
 La Center, WA 98629
 www.pacair.net

K&B Duct Flanged Duct

K&B Elbows - Flanged Pleated/Welded

Standard Radius (1.5)					
	90 deg	60 deg	45 deg	30 deg	
Dia.	Part #	Part #	Part #	Part #	GA
4"	22204.90	22204.60	22204.45	22204.30	22
5"	22205.90	22205.60	22205.45	22205.30	22
6"	22206.90	22206.60	22206.45	22206.30	22
7"	22207.90	22207.60	22207.45	22207.30	22
8"	22208.90	22208.60	22208.45	22208.30	22
9"	22209.90	22209.60	22209.45	22209.30	22
10"	22210.90	22210.60	22210.45	22210.30	20
11"	22211.90	22211.60	22211.45	22211.30	20
12"	22212.90	22212.60	22212.45	22212.30	20
13"	22213.90	22213.60	22213.45	22213.30	20
14"	22214.90	22214.60	22214.45	22214.30	20
15"	22215.90	22215.60	22215.45	22215.30	20
Long Radius (2.5)					
	90 deg	60 deg	45 deg	30 deg	
Dia.	Part #	Part #	Part #	Part #	GA
4"	22204.9L	22204.6L	22204.45L	22204.3L	22
5"	22205.9L	22205.6L	22205.45L	22205.3L	22
6"	22206.9L	22206.6L	22206.45L	22206.3L	22
7"	22207.9L	22207.6L	22207.45L	22207.3L	22
8"	22208.9L	22208.6L	22208.45L	22208.3L	22
9"	22209.9L	22209.6L	22209.45L	22209.3L	20
11"	22211.9L	22211.6L	22211.45L	22211.3L	20
12"	22212.9L	22212.6L	22212.45L	22212.3L	20
13"	22213.9L	22213.6L	22213.45L	22213.3L	20
14"	22214.9L	22214.6L	22214.45L	22214.3L	20
15"	22215.9L	22215.6L	22215.45L	22215.3L	20



Galvanized Only



NOTES:

CONSTRUCTION: These elbows are made by bending and pleating a piece of duct. The NON-Welded style starts with an un-joined piece of duct and as the pleating takes place, the overlapping edges are pressed together on the inside of the elbow. The welded elbow starts with a piece of duct that has been continuously welded down the seam. The duct is formed the same way. The weld is on the outside radius. Both are available in galvanized only.

APPLICATION: The non-welded elbow is a very cost effective elbow used in systems where a small amount of leakage is acceptable ie the wood industry. The welded elbow provides good all around usage. Both are uni-directional.

Ordering Made Easy

Your Representative: (800) 252-3993
 Pacific Air Consultants, Inc.
 PO Box 426 - 33100 NE Ivy Ave
 La Center, WA 98629
www.pacair.net

NOTES:

For parts under 24" use the price of the corresponding part in the K&B Duct line and add the price of two flanges. To create the part # simply change the first number in the K&B Duct part # from a '1' to a '2'. This will signify that the part is to be flanged.

Available in heavier gauges and larger sizes. Call for pricing.

Branches (Tee on Taper)

Dia.	Part #			GA
	30 deg	45 deg	Tee'	
See note for sizes under 24".				
24"	24024.3	24024.45	24324	18
26"	24026.3	24026.45	24326	18
28"	24028.3	24028.45	24328	18
30"	24030.3	24030.45	24330	16
32"	24032.3	24032.45	24332	16
34"	24034.3	24034.45	24334	16
36"	24036.3	24036.45	24336	16
38"	24038.3	24038.45	24338	16
40"	24040.3	24040.45	24340	16
42"	24042.3	24042.45	24342	16
44"	24044.3	24044.45	24344	16
46"	24046.3	24046.45	24346	16
48"	24048.3	24048.45	24348	16

* If using Stainless Steel, add an "SS" to the end of the part #.



NOTES:

For parts under 24" use the price of the corresponding part in the K&B Duct line and add the price of two flanges. To create the part # simply change the first number in the K&B Duct part # from a '1' to a '2'. This will signify that the part is to be flanged.

Available in heavier gauges and larger sizes. Call for pricing.

Double Branches (Tee on Taper)

Dia.	Part # s			GA
	30 deg	45 deg		
See note for sizes under 24".				
24"	24124.3	24124.45		18
26"	24126.3	24126.45		18
28"	24128.3	24128.45		18
30"	24130.3	24130.45		16
32"	24132.3	24132.45		16
34"	24134.3	24134.45		16
36"	24136.3	24136.45		16
38"	24138.3	24138.45		16
40"	24140.3	24140.45		16
42"	24142.3	24142.45		16
44"	24144.3	24144.45		16
46"	24146.3	24146.45		16
48"	24148.3	24148.45		16

* If using Stainless Steel, add an "SS" to the end of the part #.



Ordering Made Easy

Your Representative: (800) 252-3993
 Pacific Air Consultants, Inc.
 PO Box 426 - 33100 NE Ivy Ave
 La Center, WA 98629
 www.pacair.net

K&B Duct Clamp Together Duct

Y-Branches - Flanged



	Part #	Part #	
Dia	30 deg	45 deg	GA
See note for sizes under 24".			
24"	24224.3	24224.45	18
26"	24226.3	24226.45	18
28"	24228.3	24228.45	18
30"	24230.3	24230.45	16
32"	24232.3	24232.45	16
34"	24234.3	24234.45	16
36"	24236.3	24236.45	16
38"	24238.3	24238.45	16
40"	24240.3	24240.45	16
42"	24242.3	24242.45	16
44"	24244.3	24244.45	16
46"	24246.3	24246.45	16
48"	24248.3	24248.45	16

* If using Stainless Steel, add an "SS" to the end of the part #.

Galvanized and Stainless Steel

In-Cuts - Flanged

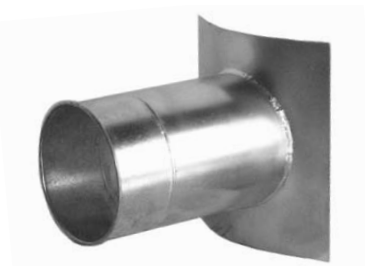

Galvanized and Stainless Steel



	Part #	Part #	Part #	
Dia	30 deg	45 deg	T's	GA
See note for sizes under 24".				
24"	24424.3	24424.45	24524	18
26"	24426.3	24426.45	24526	18
28"	24428.3	24428.45	24528	18
30"	24430.3	24430.45	24530	16
32"	24432.3	24432.45	24532	16
34"	24434.3	24434.45	24534	16
36"	24436.3	24436.45	24536	16
38"	24438.3	24438.45	24538	16
40"	24440.3	24440.45	24540	16
42"	24442.3	24442.45	24542	16
44"	24444.3	24444.45	24544	16
46"	24446.3	24446.45	24546	16
48"	24448.3	24448.45	24548	16

* If using Stainless Steel, add an "SS" to the end of the part #.

NOTES:

For parts under 24" use the price of the corresponding part in the K&B Duct line and add the price of two flanges.

To create the part # simply change the first number in the K&B Duct part # from a '1' to a '2'. This will signify that the part is to be flanged.

Available in heavier gauges and larger sizes. Call for pricing.

NOTES:

For parts under 24" use the price of the corresponding part in the K&B Duct line and add the price of two flanges.

To create the part # simply change the first number in the K&B Duct part # from a '1' to a '2'. This will signify that the part is to be flanged.

Available in heavier gauges and larger sizes. Call for pricing.

Ordering Made Easy

Your Representative: (800) 252-3993
 Pacific Air Consultants, Inc.
 PO Box 426 - 33100 NE Ivy Ave
 La Center, WA 98629
www.pacair.net

NOTES:

For parts under 24" use the price of the corresponding part in the K&B Duct line and add the price of two flanges. To create the part # simply change the first number in the K&B Duct part # from a '1' to a '2'. This will signify that the part is to be flanged.

NOTES:

Reducers are priced by large end.

Available in heavier gauges and larger sizes. Call for pricing.

NOTES:

* If using Stainless Steel, add an "SS" to the end of the part #.

Cut-Offs - Flanged

	Part #
Dia	Full
4"	28004
5"	28005
6"	28006
7"	28007
8"	28008
9"	28009
10"	28010
11"	28011
12"	28012
14"	28014
16"	28016
18"	28018
20"	28020
22"	28022



Galvanized and Stainless Steel

Blast Gates - Flanged

Dia.	Part #	GA
4"	28204	14
5"	28205	14
6"	28206	14
7"	28207	14
8"	28208	14
9"	28209	14
10"	28210	14
11"	28211	14
12"	28212	14
13"	28213	14
14"	28214	14
15"	28215	14
16"	28216	14
17"	28217	14
18"	28218	14
19"	28219	14
20"	28220	14
22"	28222	14



Galvanized and Stainless Steel

* If using Stainless Steel, add an "SS" to the end of the part #.

Reducers - Flanged

Dia	Part #	GA
See note for sizes under 24".		
24"	26024	18
26"	26026	18
28"	26028	18
30"	26030	16
32"	26032	16
34"	26034	16
36"	26036	16
38"	26038	16
40"	26040	16
42"	26042	16
44"	26044	16
46"	26046	16
48"	26048	16



Galvanized and Stainless Steel

Rectangular to Round Transitions - Flanged

	Hemmed	
Dia	Part #	GA
See note for sizes under 24".		
24"	26124	18
26"	26126	18
28"	26128	18
30"	26130	16
32"	26132	16
34"	26134	16
36"	26136	16
38"	26138	16
40"	26140	16
42"	26142	16
44"	26144	16
46"	26146	16
48"	26148	16



Galvanized and Stainless Steel

All Other Components

All K&B Duct components can be fitted with a flange in lieu of a rolled lip. The part numbers are basically the same with the exception that all flanged parts start with a '2' rather than the '1' used for the K&B Duct.

While K&B Duct is available from 4' to 22' sizes, flange ducting and components can be fabricated in ALL sizes. And while the price list shows up to 48', much larger capabilities exist.



Ordering Made Easy

Your Representative: (800) 252-3993
 Pacific Air Consultants, Inc.
 PO Box 426 - 33100 NE Ivy Ave
 La Center, WA 98629
 www.pacair.net

Total Dust Collection Control

Optimize your dust collection system.

Use of cut-offs/blast gates often threatens the integrity of the collection system and can result in poor air flow - especially when the opening and closing of the gates is left to the operator. K&B Duct's automatic gates can provide the solution to these problems by providing automatic opening and closing of the gates AT THE RIGHT TIME. Not only can the gates increase the efficiency of under-sized systems, they can also make it possible to use smaller systems where only intermittent use is required and thus effectively lower initial cost and operating cost.

K&B Duct's industrial grade gates can be tied to an electric switch or other activation controls. When activated, an electric solenoid (either low voltage or line voltage) on the unit controls the air flow to and from the air cylinder(s) (90 psi required) providing positive opening or closing. A series of gates can also be tied to a PLC controller that will control the fan's operation. Coupled with a variable frequency drive it can provide variable speed control to the fan further reducing operating cost.

Industrial Grade Cut-Offs With "Positive" Air Operation

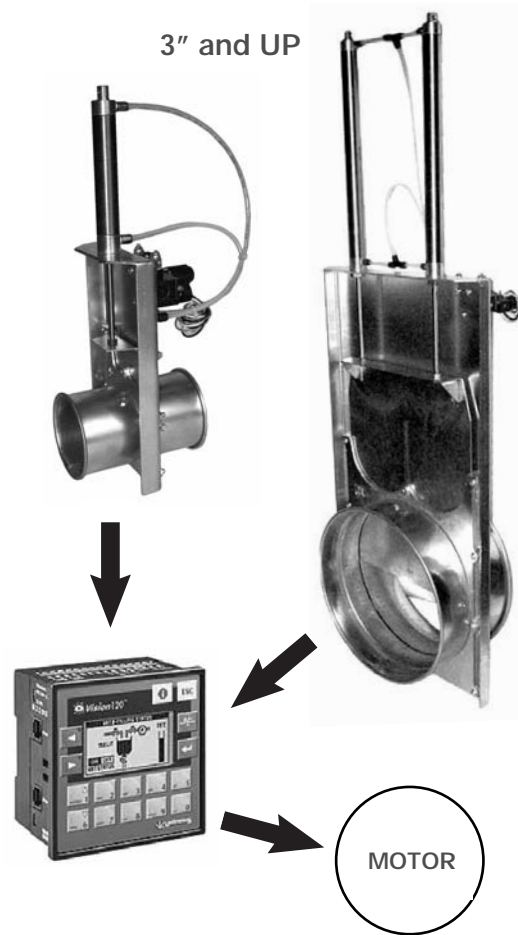

APPLICATION:

This blast gate system can be applied to existing systems to maximize suction or applied to new systems to minimize air (CFM) requirements. The variable frequency fan controller will allow some applications to realize energy savings.

Free Design Assistance.

Heavy Duty Diverter Valves

K&B Duct also offers a full line of diverter valves that can be operated manually or equipped with air cylinders for automatic operation. As with the blast gates these can be tied to specific operations or controlled by PLCs.



Ordering Made Easy

Your Representative: (800) 252-3993
Pacific Air Consultants, Inc.
PO Box 426 - 33100 NE Ivy Ave
La Center, WA 98629
www.pacair.net

ESTABLISH A STAGING AREA where all parts can be laid out in the order of assembly. Each shipment has the part # and the box that the part is in to assist you in locating the parts. It is recommended that you stage the drops separately and as close to the drop locations as possible.

ESTABLISH THE 'LINE' OF TRAVEL. You need to establish a straight line by which to install your various lines. You may use an existing beam or you may want to 'pull' a string as your straight line to insure that you are staying straight throughout your installation. Installations can begin at the fan end or the at the 'pick-ups'. However final adjustments are easier on the pick-ups and larger jobs are easier if installation starts from the fan forward. Either way, you need a pre-established 'line' to follow.

LOCATE AND INSTALL TEMPORARY HANGERS that will support the duct during the installation process. Hangers can be added and moved as duct is installed, but hangers will be needed during the installation to support the duct. If using the cable hangers—see the instructions in the catalog/price list. If using a rod attached to saddles, you will want to have the saddles attached to the rod, ready to receive the duct.

IF USING 'K-WICK' CABLE HANGERS – then refer to illustration below. Figure A represents the forming of a loop around a beam or other object from which the duct will be suspended. Figure B and C illustrate the way the cable goes through the clucher around the duct and back through the clucher. A "thumb tab" allows for release of the cable.

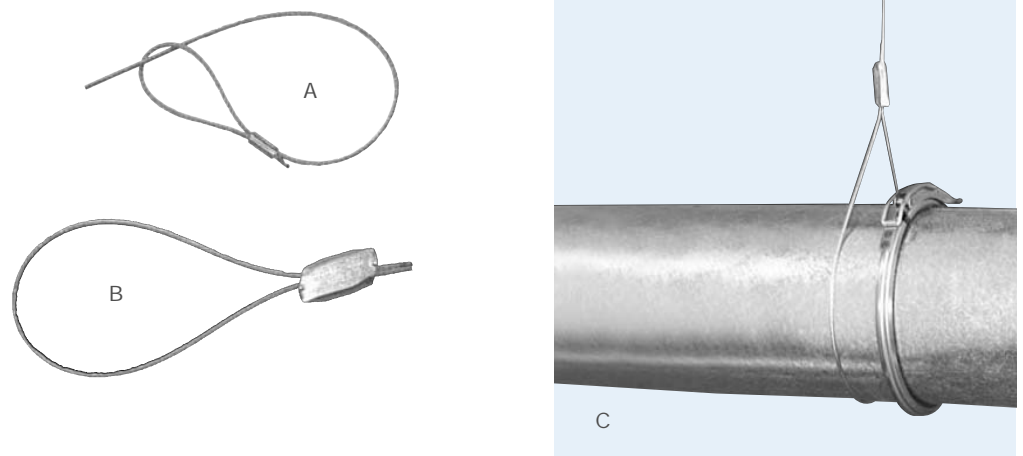

CLAMP TOGETHER STRAIGHT RUNS ON THE FLOOR – but limit the lengths to a manageable number of pieces. Remember that the longer the duct the harder it is to maneuver and the more hangers you will need.

ALWAYS INSTALL CLEVIS PIN IN CLAMP as soon as it is latched. This is especially important during installation so as to avoid accidental unclamping.

Ordering Made Easy

Your Representative: (800) 252-3993
Pacific Air Consultants, Inc.
PO Box 426 - 33100 NE Ivy Ave
La Center, WA 98629
www.pacair.net

K&B Duct Installation Tips

FIT TO LENGTH where necessary. The duct is 5' long and of course must be cut/fitted to address shorter needs. An adjustable sleeve is incorporated in the system and provides for infinite adjustment of lengths 12" to app 5'10". Shorter (1"-11") incremental adjustments can be achieved using the adjustment capability of the collars on the end of the various fittings.

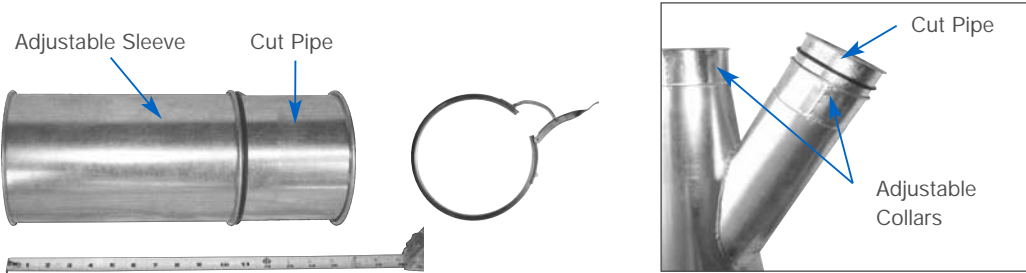

FIT TO LENGTH where necessary. The duct is 5' long and of course must be cut/fitted to address shorter needs. An adjustable sleeve is incorporated in the system and provides for infinite adjustment of lengths 12" to app 5'10". Shorter (1"-11") incremental adjustments can be achieved using the adjustment capability of the collars on the end of the various fittings.

Step 1. For a sleeve - Cut a standard length of pipe to a length slightly shorter than what you need to make the connections. For a fitting - Cut a standard length of pipe slightly longer than the length needed.

Step 2. Slide cut piece of pipe into the fitting and use an O-ring and clamp to secure the fit.

FINAL CONNECTIONS TO MACHINES/DUST PORTS/ETC is often best accomplished using flex hose. While hard ducting to the port is often preferred, the flex hose provides a great deal of 'forgiveness' in the hook-up. Simply clamp your hose adapter to the end of the duct and a machine adapter to the port. Then slide the flex hose over the end and clamp with a worm clamp.

NOTE: MIST INSTALLATIONS require that the duct and clamps of horizontal runs be installed with the seams and clamp handles are on the top of the duct. Adjustable sleeves (usually installed with respect to air flow) must be installed with respect to 'drainage'. For example: In a vertical drop, the sleeve should be at the bottom of the assembly with the cut end of the pipe facing down. Special gasketing in the clamps is also an important consideration. Make sure that the clamps are fitted with appropriate material. Heavy applications can be further secured with silicone or other sealants.

Ordering Made Easy

Your Representative: (800) 252-3993
Pacific Air Consultants, Inc.
PO Box 426 - 33100 NE Ivy Ave
La Center, WA 98629
www.pacair.net

Once the basics of duct design are understood, the process can be carried through to ANY size duct system. Air losses are so small with the K&B clamp and components, that no additional allowances need to be made. The following example provides the basics of design. It is based on 4500 FPM.

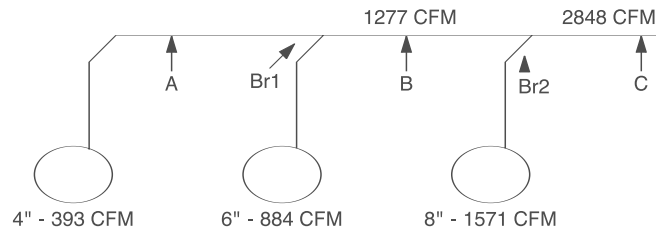

In this system, we are using openings of 4", 6", and 8". In most systems, the dust portal of the machine is measured and used as a 'given'.

The size of duct 'A' is of course 4" because the CFM in the system is constant until the next branch at which point the 6" line feeds into the system. At this point the collective CFM is 1277. Using the velocity/volume chart we look for 1277 CFM under 4500'/min. However we find that it falls between duct size 7" and 8". By rounding to the nearest number, we find that 7" is the closest number. 'B' is therefore best sized at 7".

Branches, also called 'T on Taper', are sized by the large end and called out by A-B-C.

The branch 'BR 1' is therefore a 7" branch, tapering to a 4", with a 6" lateral. This is listed as a 7-4-6.



Continuing on the 8" line feed into the 7" line (B) and the collective CFM is now 2848. Referring to the chart, the best selection for 'C' is an 11" duct and the branch (Br2) is called out by 11-7-8.

Using the same process, any size system can now be sized by just adding the collective CFM and using the chart. Even if you have multiple branches as for example a 18" and a 22" branch running coming together. The total CFM would be app. 19838. This then would require a combined duct size of 28". See chart.

Volume-Velocity Table in Std. CFM.

Dia.	3000'/min	3500'/min	4000'/min	4500'/min	Dia.	3000'/min	3500'/min	4000'/min	4500'/min
2"	65	76	87	98	23"	8659	10102	11545	12988
3"	147	172	196	221	24"	9428	10999	12571	14142
4"	262	306	349	393	25"	10230	11935	13640	15345
5"	409	477	546	614	26"	11065	12909	14753	16597
6"	589	687	786	884	27"	11932	13921	15910	17899
7"	802	936	1069	1203	28"	12833	14971	17110	19249
8"	1048	1222	1397	1571	29"	13766	16060	18354	20649
9"	1326	1547	1768	1989	30"	14731	17187	19642	22097
10"	1637	1910	2182	2455	31"	15730	18352	20973	23595
11"	1981	2311	2641	2971	32"	16761	19555	22348	25142
12"	2357	2750	3143	3536	33"	17825	20796	23767	26738
13"	2766	3227	3688	4149	34"	18922	22075	25229	28383
14"	3208	3743	4278	4812	35"	20051	23393	26735	30077
15"	3683	4297	4910	5524	36"	21213	24749	28284	31820
16"	4190	4889	5587	6285	38"	23636	27575	31514	35454
17"	4730	5519	6307	7096	40"	26189	30554	34919	39284
18"	5303	6187	7071	7955	42"	28874	33686	38498	43310
19"	5909	6894	7879	8863	44"	31689	36970	42252	47533
20"	6547	7639	8730	9821	46"	34635	40408	46180	51953
21"	7218	8421	9625	10828	48"	37712	43998	50283	56569
22"	7922	9243	10563	11883					



Use this worksheet to tally your requirements. Fax it to K&B at 1-336-668-0043 and we will provide you with a quote, usually within 4 hours. You may also obtain a copy of this on Excel that will count your clamp, and check your request — alerting you to any possible discrepancies such as too few sleeves or the wrong branches. Simply call K&B to obtain the spreadsheet disc.

Name _____

Company Name _____

Phone _____ Fax _____

PIPE	ADJ SLEEVE	ELBOWS				K&B ELBOWS				CLAMP	Sngl BR.	Dbl. BR.	Y-BRNCH	T-BRNCH	IN-CUT	ADPT	REDUCER	REC-TO ROUD	HOOD	MANI-FOLD	BLAST GATE	HOSE	HOSE ADAPTER		
		90	60	45	30	90	60	45	30																
3"																									
4"																									
5"																									
6"																									
7"																									
8"																									
9"																									
10"																									
11"																									
12"																									
13"																									
14"																									
15"																									
16"																									
17"																									
18"																									
19"																									
20"																									
22"																									

Indicate here if you desire welded K&B Elbows



Use this worksheet to tally your requirements. Fax it to K&B at 1-336-668-0043 and we will provide you with a quote, usually within 4 hours. You may also obtain a copy of this on Excel that will count your clamp, and check your request — alerting you to any possible discrepancies such as too few sleeves or the wrong branches. Simply call K&B to obtain the spreadsheet disc.

Name _____

Company Name _____

Phone _____ Fax _____

PIPE	ADJ SLEEVE	ELBOWS				K&B ELBOWS				CLAMP	Sngl BR.	Dbl. BR.	Y-BRNCH	T-BRNCH	IN-CUT	ADPT	REDUCER	REC-TO ROUD	HOOD	MANI-FOLD	BLAST GATE	HOSE	HOSE ADAPTER		
		90	60	45	30	90	60	45	30																
3"																									
4"																									
5"																									
6"																									
7"																									
8"																									
9"																									
10"																									
11"																									
12"																									
13"																									
14"																									
15"																									
16"																									
17"																									
18"																									
19"																									
20"																									
22"																									

Indicate here if you desire welded K&B Elbows



www.KBDuct.com

Representative:

Pacific Air Consultants, Inc.
P.O. Box 426
33100 NE Ivy Ave.
La Center, WA 98629

800.252.3993
Fax: 360.263.9772

www.pacair.net



www.cecoenviro.com
NASDAQ: CECE

K&B reserves the right to make changes to product line. All parts are finalized through quote.
©2005 2/05 2M